

1

2

3

* closed hole

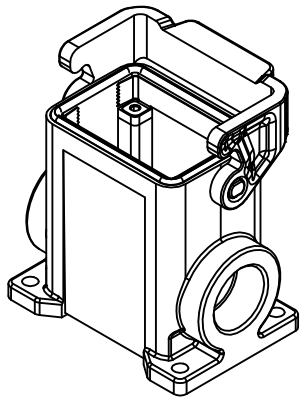
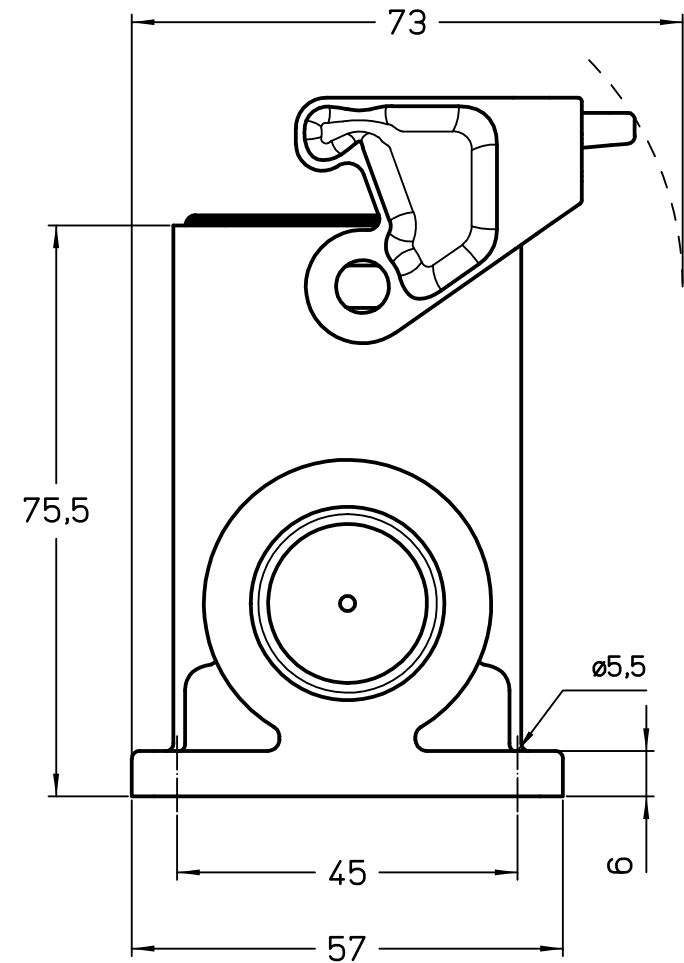
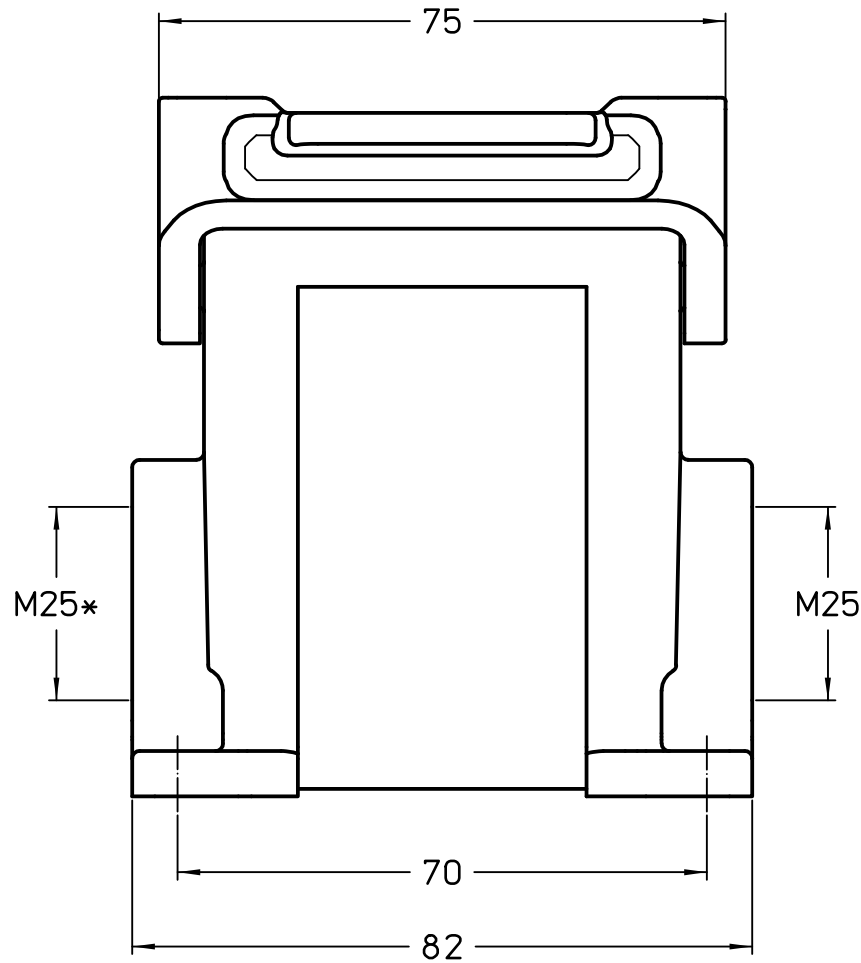

Dimensions
in mm

Simplified representation with dimensions without tolerance

Original Size A4

TAPH 06L25B

Date 14/02/22

Insulating surface mounting housing, size "44.27", 1x M25 side entry,

Sign. G. Renna

with 1 lever, with integrated PE jumpers - HYGIENIC

Scale
1:1



1

2

3